

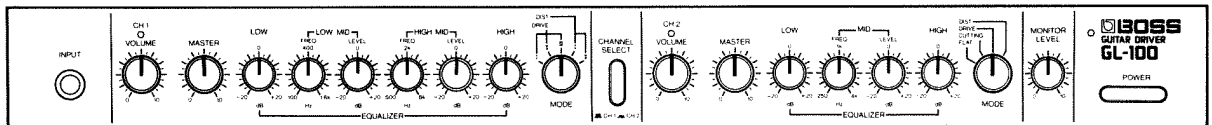



GUITAR DRIVER

GL-100

Owner's Manual



	CAUTION RISK OF ELECTRIC SHOCK DO NOT OPEN	
ATTENTION : RISQUE DE CHOC ELECTRIQUE NE PAS OUVRIR		
CAUTION: TO REDUCE THE RISK OF ELECTRIC SHOCK, DO NOT REMOVE COVER (OR BACK). NO USER-SERVICEABLE PARTS INSIDE. REFER SERVICING TO QUALIFIED SERVICE PERSONNEL.		



The lightning flash with arrowhead symbol, within an equilateral triangle, is intended to alert the user to the presence of un-insulated "dangerous voltage" within the product's enclosure that may be of sufficient magnitude to constitute a risk of electric shock to persons.



The exclamation point within an equilateral triangle is intended to alert the user to the presence of important operating and maintenance (servicing) instructions in the literature accompanying the product.

INSTRUCTIONS PERTAINING TO A RISK OF FIRE, ELECTRIC SHOCK, OR INJURY TO PERSONS.

IMPORTANT SAFETY INSTRUCTIONS

WARNING — When using electric products, basic precautions should always be followed, including the following:

1. Read all the instructions before using the product.
2. Do not use this product near water — for example, near a bathtub, washbowl, kitchen sink, in a wet basement, or near a swimming pool, or the like.
3. This product should be used only with a cart or stand that is recommended by the manufacturer.
4. This product, either alone or in combination with an amplifier and headphones or speakers, may be capable of producing sound levels that could cause permanent hearing loss. Do not operate for a long period of time at a high volume level or at a level that is uncomfortable. If you experience any hearing loss or ringing in the ears, you should consult an audiologist.
5. The product should be located so that its location or position does not interfere with its proper ventilation.
6. The product should be located away from heat sources such as radiators, heat registers, or other products that produce heat.
7. The product should avoid using in where it may be effected by dust.
8. The product should be connected to a power supply only of the type described in the operating instructions or as marked on the product.
9. The power-supply cord of the product should be unplugged from the outlet when left unused for a long period of time.
10. Do not tread on the power-supply cord.
11. Do not pull the cord but hold the plug when unplugging.
12. When setting up with any other instruments, the procedure should be followed in accordance with instruction manual.
13. Care should be taken so that objects do not fall and liquids are not spilled into the enclosure through openings.
14. The product should be serviced by qualified service personnel when:
 - A. The power-supply cord or the plug has been damaged; or
 - B. Objects have fallen, or liquid has been spilled into the product; or
 - C. The product has been exposed to rain; or
 - D. The product does not appear to operate normally or exhibits a marked change in performance; or
 - E. The product has been dropped, or the enclosure damaged.
15. Do not attempt to service the product beyond that described in the user-maintenance instructions. All other servicing should be referred to qualified service personnel.

SAVE THESE INSTRUCTIONS

For the U.K.

IMPORTANT: THE WIRES IN THIS MAINS LEAD ARE COLOURED IN ACCORDANCE WITH THE FOLLOWING CODE.
BLUE: NEUTRAL, BROWN: LIVE

As the colours of the wires in the mains lead of this apparatus may not correspond with the coloured markings identifying the terminals in your plug proceed as follows:

- The wire which is coloured BLUE must be connected to the terminal which is marked with the letter N or coloured BLACK.
- The wire which is coloured BROWN must be connected to the terminal which is marked with the letter L or coloured RED.

Thank you for purchasing the BOSS Guitar Driver GL-100. The GL-100 is a preamplifier that contains a line driver simulating a large size tube guitar amplifier. It can generate various different sounds. To make the best use of the GL-100, please read the owner's manual carefully.

■ FEATURES

- The GL-100 contains a line driver simulating a large size tube guitar amplifier. By connecting a mixer or power amplifier directly to the GL-100, powerful guitar sounds can be produced.
- The GL-100 has simulation circuits individually in the amplifier section and the speaker section. The simulation circuit in the speaker section can be turned on or off, and therefore can be used either for a monitor speaker or guitar speaker.
- The GL-100 contains two types of preamplifier (CH1 and CH2). You can use either of them. CH 1 gives you ideal sounds for lead performance, while CH 2's sounds are suitable for backing. Using the optional foot switch, the channels can be changed with the pedal.
- CH 1 features a 4 band equalizer and CH 2 a 3 band equalizer, allowing you to control the sound delicately.
- By changing modes, many different sounds, from clear sound to hard distortion sound can be created.
- Provided with the Send/Return (stereo) jacks, the GL-100 can be connected with an effect unit such as a reverb, chorus and delay.
- The GL-100 features two types of output sockets, standard phone jack and XLR (balance) type connector, and therefore can be used in various occasions, for recording or on stage, etc.

■ IMPORTANT NOTES

In addition to the items listed under Safety Precautions, on page 2, we request that you please read and adhere to the following.

Concerning the power supply

- Whenever you make any connections with other devices, always turn off the power to all equipment first. This will help in preventing malfunction, and damage to speakers.
- Do not force the unit to share the same power outlet as one used for distortion producing devices (such as motors, variable lighting devices). Be sure to use a separate power outlet.

Concerning placement

- Placing the unit near power amplifiers or other equipment containing large transformers may induce hum.

Maintenance

- For everyday cleaning, wipe the unit with a soft dry cloth, or one that is dampened slightly. To remove dirt that is more stubborn, wipe using a mild, neutral detergent. Afterwards, make sure to wipe thoroughly with a soft cloth.
- Never apply benzene, thinners, alcohol or any like agents, to avoid the risk of discoloration and deformation.

Other Precautions

- Protect the unit from strong impact.
- A certain small amount of heat will be radiated from the unit, and thus should not be considered abnormal.
- Before using the unit in a foreign country, check first with your local Roland Service Station.

PANEL DESCRIPTION

«Front Panel»

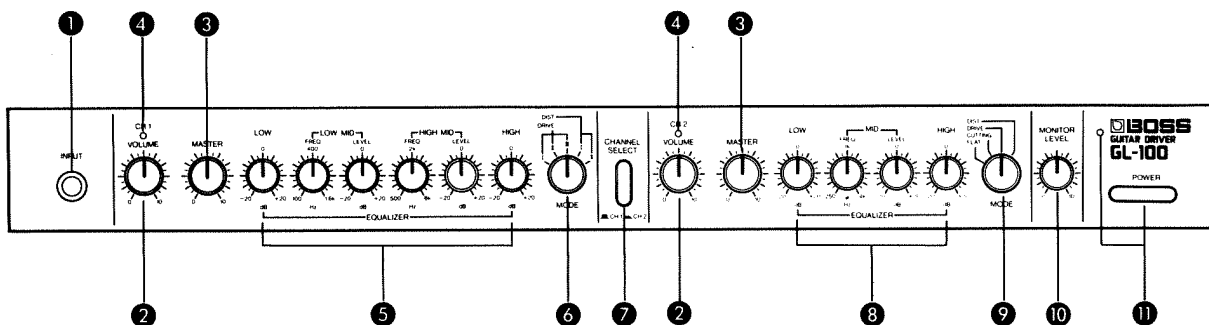

1 Input Jack

Connect a guitar to this jack.

2 Volume Control Knob

This adjusts the input level of each CH1 and CH2. Clockwise rotation will increase the input level, creating distorted sounds.

3 Master Knob

This adjusts the volume of each CH1 and CH2.

* Adjust the depth of distortion with the Volume Control Knob and the volume with the Master Knob.

4 Channel Indicator

The indicator of the selected channel, CH1 or CH2, will be lit.

5 4 Band Parametric Equalizer

This controls the sound of CH1. Clockwise rotation (↻) will boost frequencies, while counterclockwise rotation (↺) will cut them. The variable range for boosting and cutting is from -20 to $+20$ dB.

LOW: The volume of lower frequencies (lower than 100 Hz) is controlled.

LOW-MID: The volume of middle frequencies (100Hz to 1.6kHz) is controlled. Select the frequency to be boosted or cut with FREQ, then set the amount of boosting or cutting with LEVEL.

HIGH-MID: The volume of middle frequencies (500Hz to 8kHz) is controlled. Select the frequency to be boosted or cut with FREQ, then set the amount of boosting or cutting with LEVEL.

HIGH: The volume of higher frequencies (higher than 8kHz) is controlled.

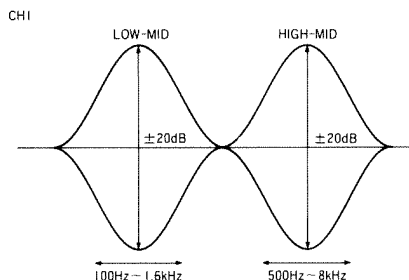
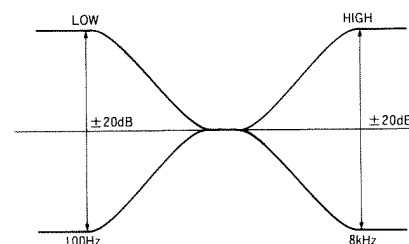

6 Mode

One of the five modes can be selected. It determines the basic sound of CH1.

DRIVE I : This is a simulation of a two-speaker tube guitar amplifier. Clear sounds can be obtained.

DRIVE II : This is a simulation of a large size tube guitar amplifier that is often used for Rock or Fusion music. Distorted sound can be obtained.

DRIVE III: This is a simulation of three stage stacking of large tube amplifiers often used for Heavy Metal music. Hard distorted sound can be obtained.

DIST I : Normal distortion sound can be obtained.

DIST II: Unique distortion sound by equalizing effect is obtained.

7 Channel Selector Switch

Use this switch to select CH1 or CH2. When the switch is pressed down, CH2 is selected.

8 3 Band Parametric Equalizer

This controls the sound of CH2. Clockwise rotation (↻) will boost frequencies, while counterclockwise rotation (↺) will cut them. The variable range for boosting and cutting is from -20 to $+20$ dB.

LOW: The volume of lower frequencies (lower than 100 Hz) is controlled.

LOW-MID: The volume of middle frequencies (250Hz to 4kHz) is controlled. Select the frequency to be boosted or cut with **FREQ**, then set the amount of boosting or cutting with **LEVEL**.

HIGH: The volume of higher frequencies (higher than 8kHz) is controlled.

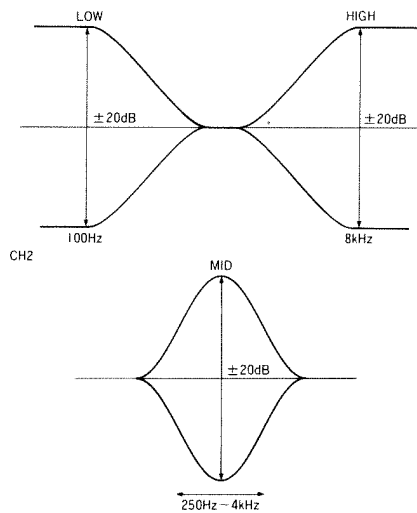

9 Mode Selector Switch

One of the four modes can be selected. It determines the basic sound of CH2.

FLAT: Flat frequency sound is obtained.

CUTTING: Clear sound is obtained. It is ideal for cutting performance. Electric acoustic guitar like sounds can be generated by using an electric guitar.

DRIVE: This is a simulation of a two-speaker type tube guitar amplifier. Clear sounds can be obtained.

DIST: Normal distortion sound can be obtained.

* In the FLAT or CUTTING mode, the simulation circuit in the speaker section does not function.

10 Monitor Output Level Knob

This controls the output level from the Monitor Output Jack.

11 Power Switch, Power Indicator

The Power Indicator lights up when the unit is switched on.

* This unit does not work for a while after being switched on. This is for protecting the internal circuits.

«Rear Panel»

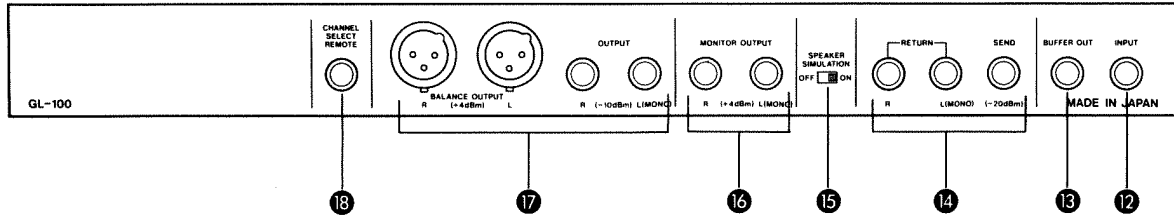

12 Input Jack

Connect a guitar to this jack.

- * When both Input Jacks on the front and rear of the unit are used at the same time, the one on the front panel will work.

13 Buffer Out Jack

Through this jack, an exact copy of the signal from the guitar is output. Use this to send guitar signal to the other device or to connect a tuner.

14 Send/Return (L/R) Jacks

These are input and output jacks for connecting an effect unit.

Connect the input of the effect unit to the Send Jack, and connect the output of the effect unit to the Return Jack. If you use an effect unit with stereo output, connect each output of the effect unit to the Return (L/R) Jacks. If you use a monaural output effect unit, connect to the Return (L) Jack.

- * When the effect unit features a level selector switch, set it to the -20dBm position. The input/output level of the BOSS Compact Series is set to -20dBm , so that you do not need to change it.

15 Speaker Simulation Switch

When this switch is set to OFF, the input signal is output without going to the simulation circuit of the speaker section. When using a speaker for a guitar, set this switch to OFF. (See Setup Example 2 and 3.)

16 Monitor Output L/R Jacks

To these jacks, connect a monitor amplifier, audio amplifier, tape recorder, etc. The output level from the Monitor Output can be adjusted with the Monitor Output Level Knob on the front panel.

- * For monaural output, use the L jack.

17 Output (L/R) Jacks

Use these jacks to connect a mixer, etc. Two types of jacks, unbalance type standard phone jack (-10dBm) and balance type XLR connector ($+4\text{dBm}$) are provided. These two jacks can be used at the same time.

Each Output Jack sends signal as shown below. It varies depending how the effect units are connected.

Send/Return Jack	Unbalance Output	Balance Output
Effect unit with Stereo Output	L/R: Stereo Output L: Mono Output	L/R: Stereo Output
Effect unit with Mono Output	L/R: Mono Output	
When no Effect unit is connected		

- * The output level from the Output Jack L/R cannot be controlled with the Monitor Output Level Knob on the front panel. To connect a unit other than a mixer to the GL-100, use the Monitor Output Jack instead.

- * The pin positions of the XLR Connector are shown below. Check it before connecting a cable to the connector.

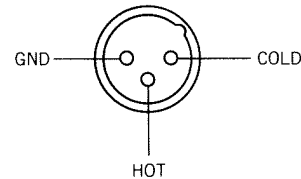

18 Channel Select Remote Jack

Connecting the optional foot switch FS-5L to this jack, you can select CH1 or CH2 with the pedal operation.

- * When this jack is being connected, the Channel Selector Switch on the front panel does not serve for channel (CH1 or CH2) selection.

SOUND SETTING EXAMPLES

Study the following examples and make your original sounds.

• Rock Lead 1 (CH1)

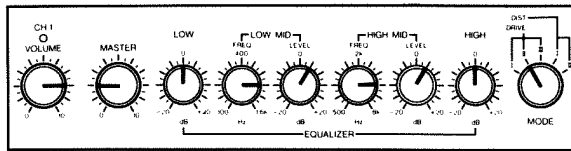

• Cutting 2 (CH2)

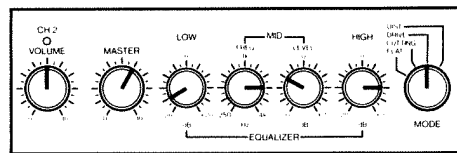

• Rock Lead 2 (CH1)

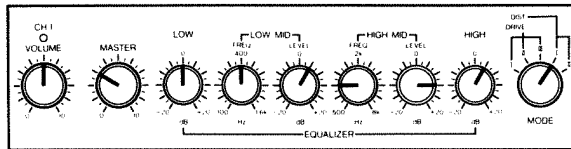

• Arpeggio (CH2)

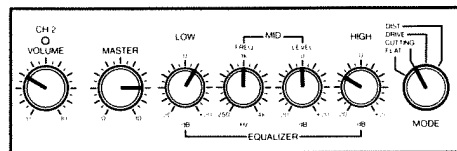

• Rock Backing 1 (CH1)

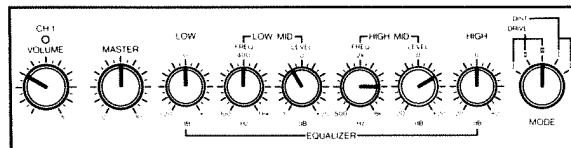

• Mellow Lead (CH1)

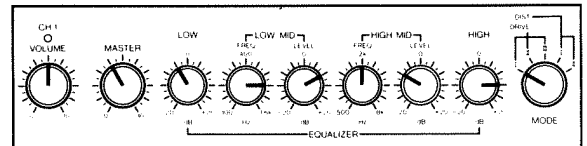

• Rock Backing 2 (CH2)

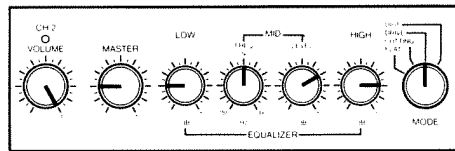

• Fusion Lead (CH1)

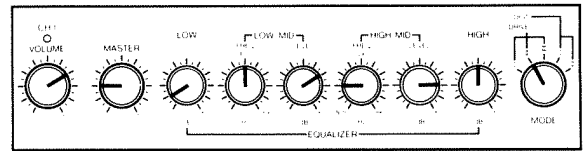

• Heavy Metal Lead 1 (CH1)

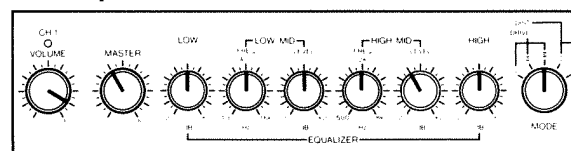

• Jazz Lead (CH1)

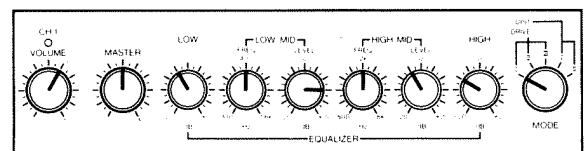

• Heavy Metal Lead 2 (CH1)

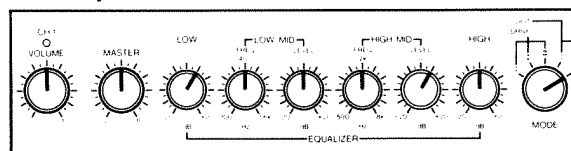

• Jazz Backing (CH2)

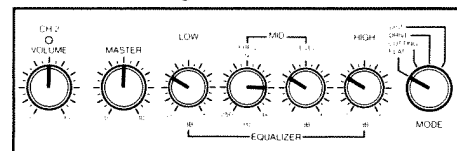

• Heavy Metal Backing 1 (CH1)

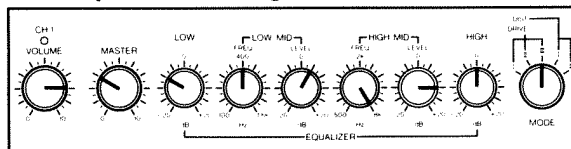

• West Coast (CH1)

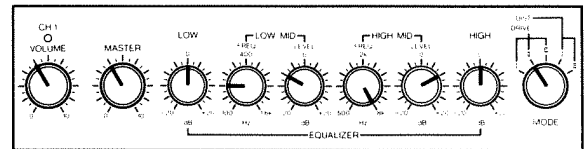

• Heavy Metal Backing 2 (CH2)

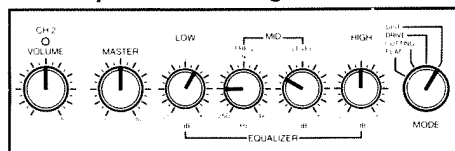

• Liverpool (CH2)

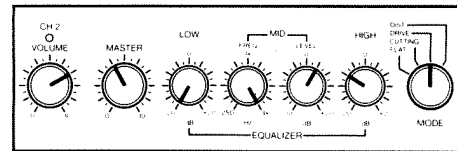

• Cutting 1 (CH2)

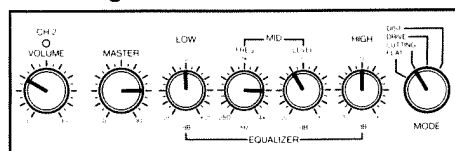

• 60's Fazz (CH1)

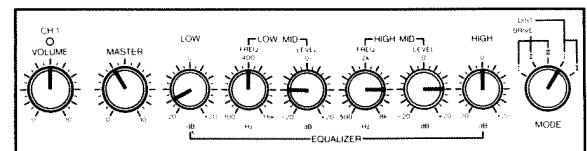

CONNECTIONS

Study the following setup examples and set up your GL-100.

* When switching on or off the GL-100, be sure to set the volume to the connected amplifier to zero.

● **Setup Example 1: This is the basic setup.**

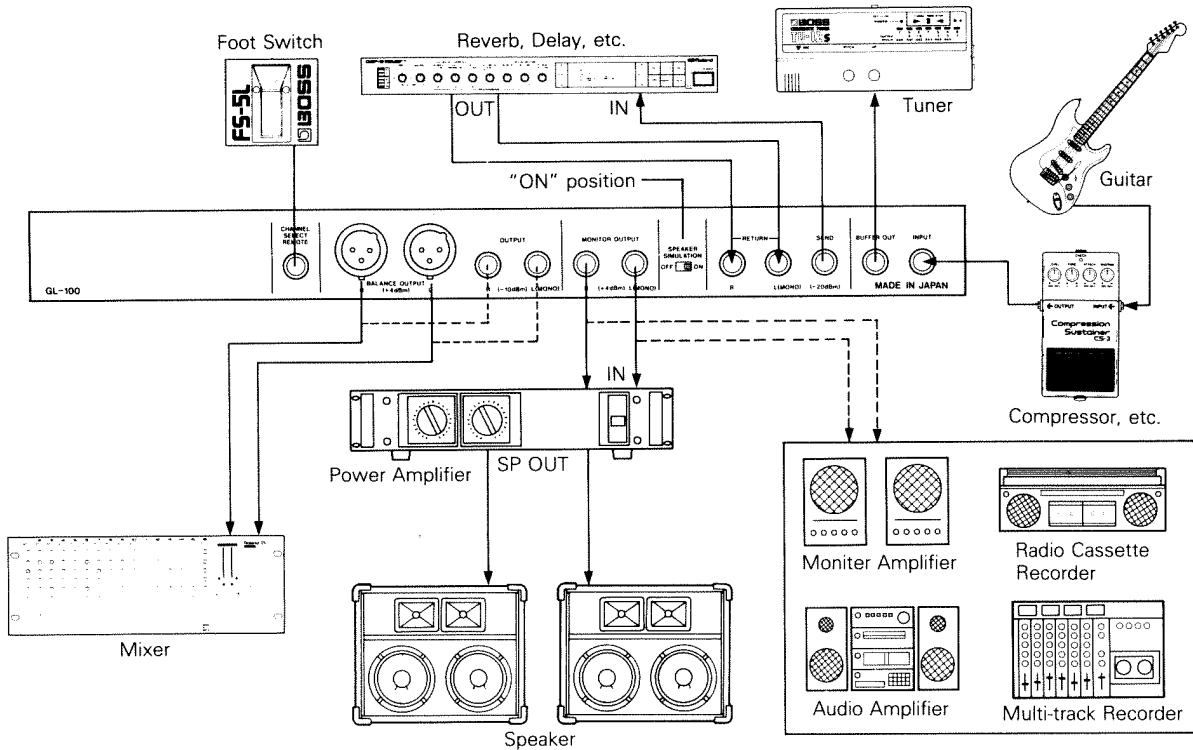

* When using audio system or tape recorder, be sure to set the volume fairly low to avoid damaging the speaker.

● **Setup Example 2: Setup with a power amplifier and a guitar speaker.**

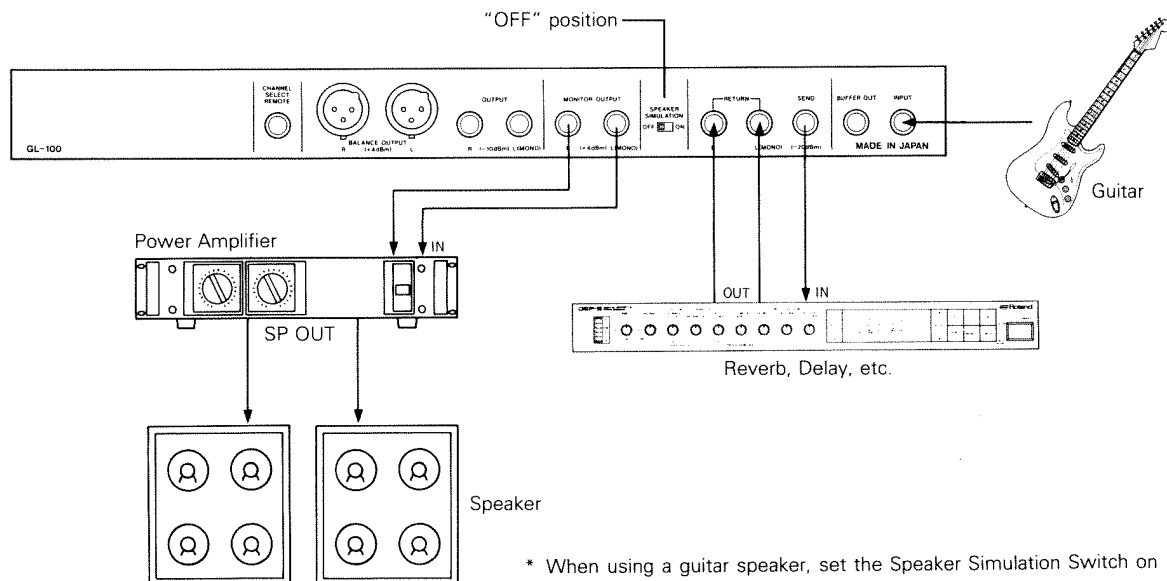

* When using a guitar speaker, set the Speaker Simulation Switch on the rear of the GL-100 to OFF.

• **Setup Example 3: Setup with a guitar amplifier.**

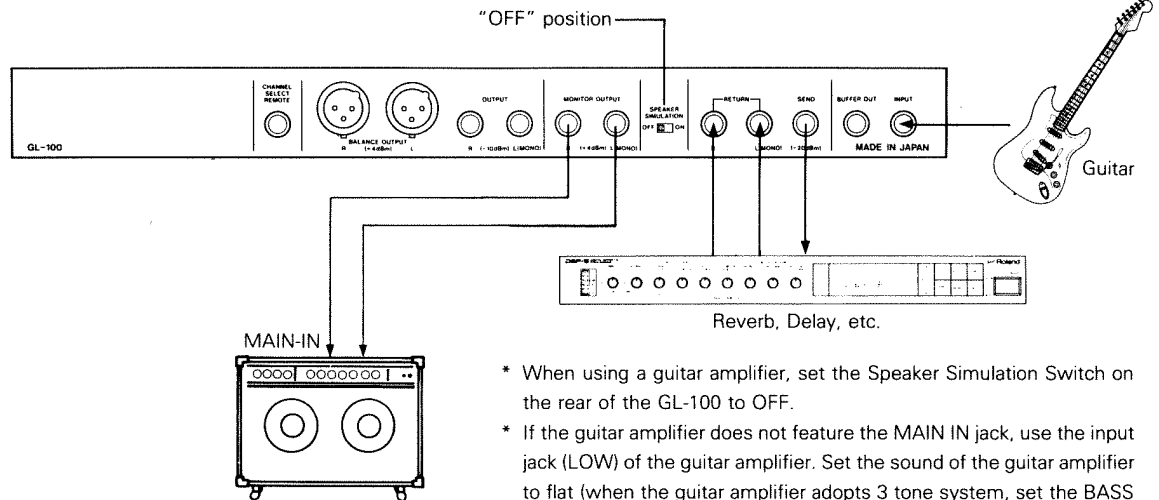

- * When using a guitar amplifier, set the Speaker Simulation Switch on the rear of the GL-100 to OFF.
- * If the guitar amplifier does not feature the MAIN IN jack, use the input jack (LOW) of the guitar amplifier. Set the sound of the guitar amplifier to flat (when the guitar amplifier adopts 3 tone system, set the BASS and TREBLE to zero and the MIDDLE to 10), then adjust the tone with the GL-100's equalizer.

• **Setup Example 4: Setup with the Noise Suppressor NS-2**

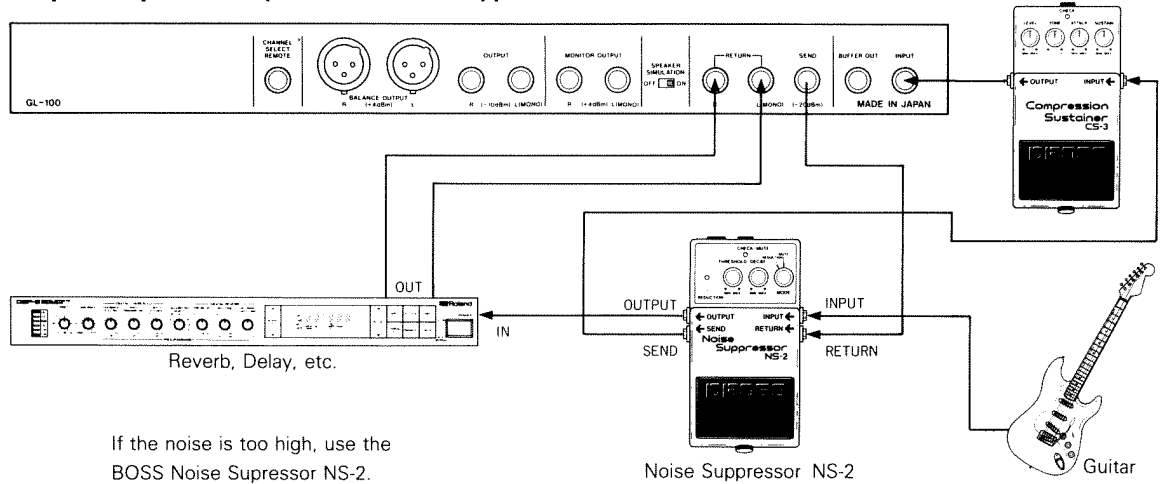

If the noise is too high, use the BOSS Noise Suppressor NS-2.

• **Setup Example 5: Setup with the Roland GP-8 (Guitar Effect Processor), BOSS ME-5 (Guitar Multiple Effects).**

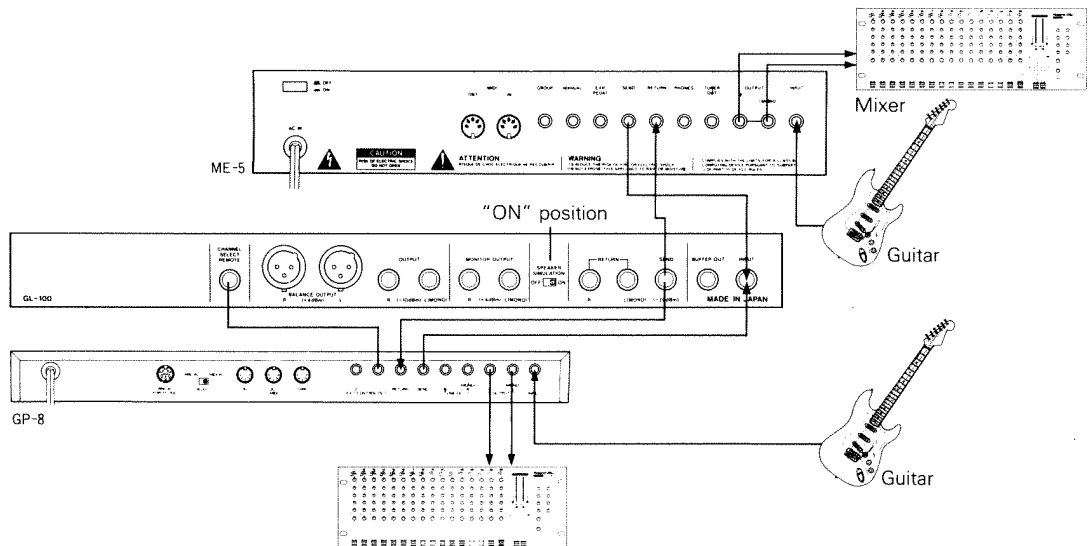

DIMENSIONS

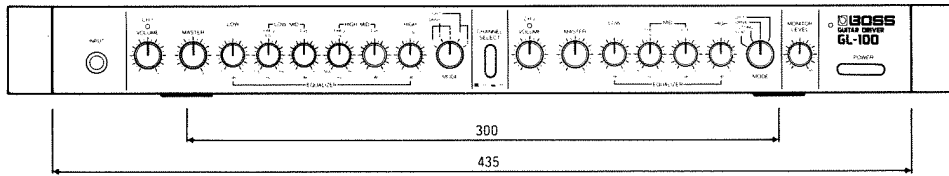
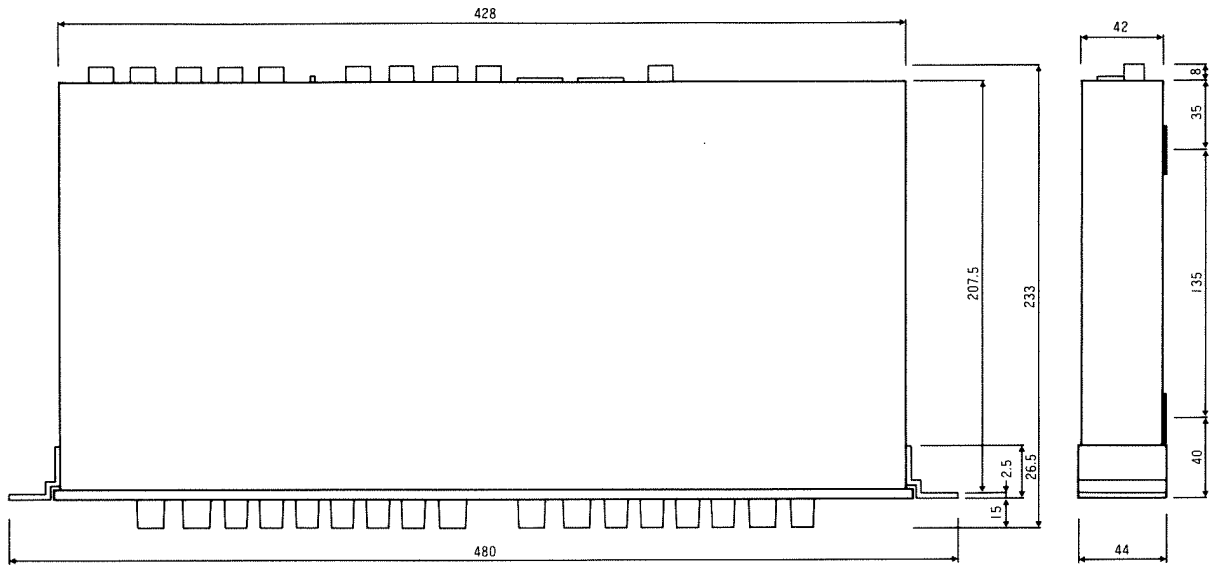

INSTALLATION OF THE ANGLE

To mount the GL-100 on a rack, remove the screws on both sides (two on each side), and attach the supplied Angle as shown below.

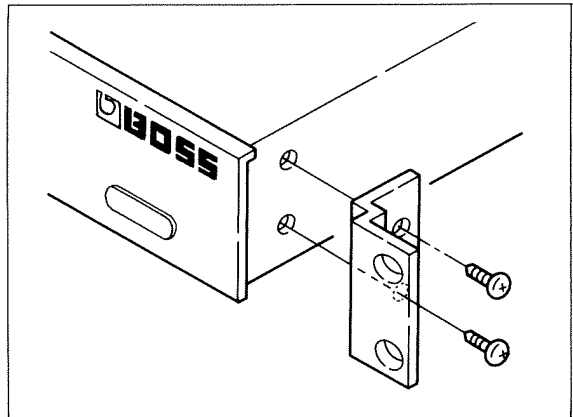

SPECIFICATIONS

• INPUT

Input Level (Rated): -20dBm

Input Impedance: 1M Ω

• BUFFER OUT

Output Level (Rated): -20dBm

Output Load Impedance: More than 10k Ω

• SEND OUT

Output Level (Rated): -20dBm

Output Load Impedance: More than 10k Ω

• RETURN L/R

Input Level (Rated): -20dBm

Input Impedance: 47k Ω

• MONITOR OUTPUT L/R

Output Level (Rated): -10dBm

Output Load Impedance: More than 10k Ω

• OUTPUT L/R

Output Level (Rated): -10dBm

Output Load Impedance: More than 50k Ω

• BALANCE OUTPUT L/R

Output Level (Rated): +4dBm

Output Load Impedance: 600 Ω

1-GND (Earth)

2-COLD (Cold)

3-HOT (Hot)

• EQUALIZER

Boost/Cut: \pm 20dB

◀CH 1▶

Low: 100 Hz (Shelving)

Low Mid: 100 Hz to 1.6kHz (Peaking)

High Mid: 500 Hz to 8kHz (Peaking)

High: 8kHz (Shelving)

◀CH 2▶

Low: 100 Hz (Shelving)

Mid: 250 Hz to 4kHz (Peaking)

High: 8kHz (Shelving)

• CONTROLS

◀CH 1▶

Volume

Master

4 Band Equalizer

Low

Low Mid Frequency

Low Mid Level

High Mid Frequency

High Mid Level

High

Mode

◀CH 2▶

Volume

Master

3 Band Equalizer

Low

Mid Frequency

Mid Level

High

Mode

Monitor Level

• SWITCHES

Power

Channel Selector

Speaker Simulation

• JACKS/CONNECTORS

Input (Front/Rear)

Buffer Out

Send

Return L/R

Monitor Output L/R

Output L/R

Balance Output L/R

• **POWER:** AC 120, 220 or 240V

• **CONSUMPTION:** 10W

• DIMENSIONS

480(W)×44(H)×233(D)mm

18-7/8"×1-3/4"×9-3/16"

• **WEIGHT:** 2.6kg/5lb 12oz

• ACCESSORY

Angle (for rack mounting) × 2

• OPTIONS

BOSS Foot Switch FS-5L

* Specifications are subject to change without notice.

SOUND SETTING MEMO

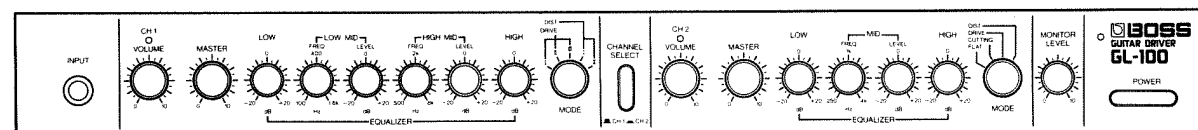
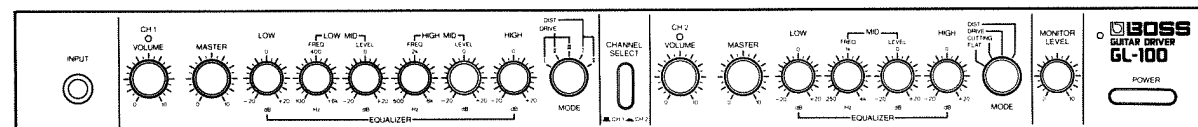
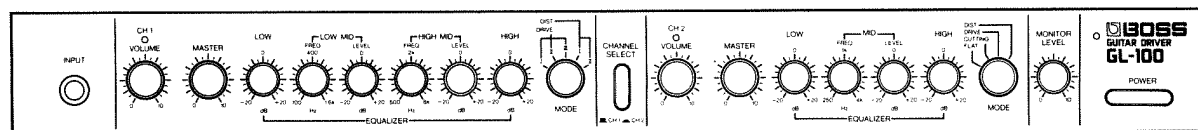
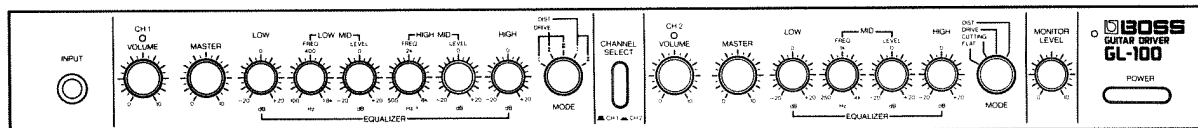
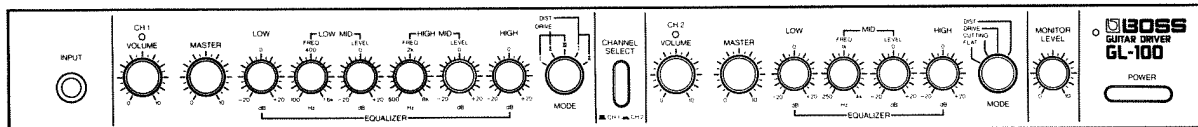
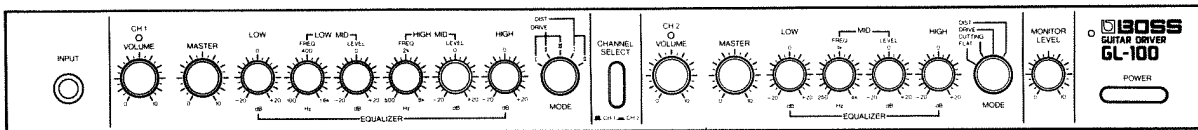

BLOCK DIAGRAM

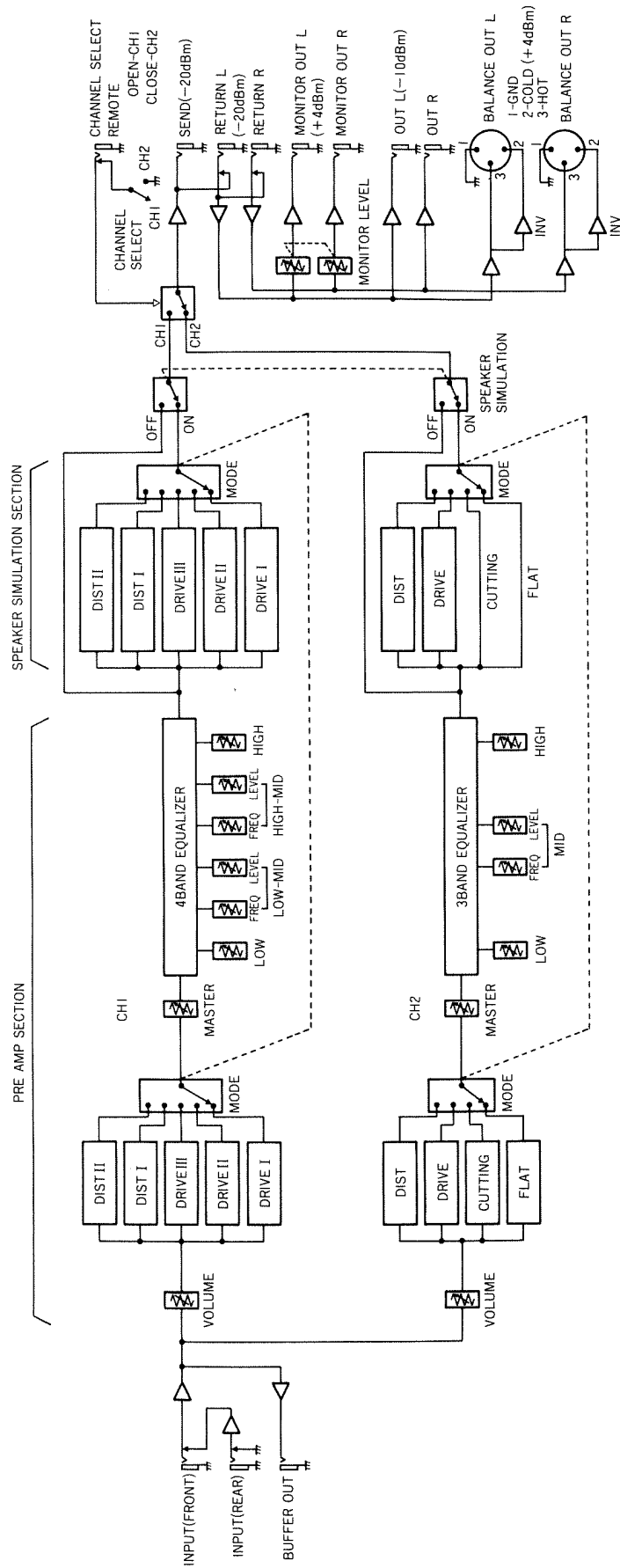

 Roland®

10950

UPC 10950



10981

 **BOSS**
Products of Roland

'89-3-E3-11Y